

KEMET Part Number: R75PD1470AA40K
(75PD1470AA40K)

Capacitor, film, 4700 pF, +/-10% Tol, -55/+105C, Pulse, 630V@85C, Lead Spacing=7.5 mm

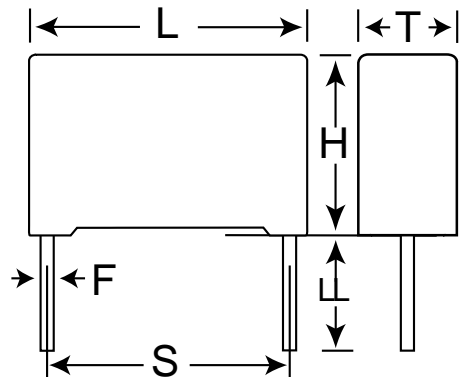

Dimensions (mm)		
Symbol	Dimension	Tolerance
L	10	+0.2
H	9	+0.1
T	4	+0.1
S	7.5	+/-0.4
LL	4	+2
F	0.5	+/-0.05

Notes:

-L,H,T are nominal dimensions and do not imply a minimum.

General Information

Supplier:	KEMET
Miscellaneous Electrical:	Not for new design. Use F461KF472K630C (series F461)

Specifications

Capacitance:	4700 pF
Rated Temperature:	85C
Voltage @ rated temp:	630V
Voltage AC:	250VAC
Tolerance:	+/-10%
Body Type:	Radial Box
Dielectric:	Metallized Polypropylene
Application:	Pulse
Temperature Range:	-55/+105C
Dissipation Factor @ 1 kHz:	0.04%
Dissipation Factor @ 10 kHz:	0.06%
Dissipation Factor @ 100kHz:	0.25%
Insulation Resistance:	100 GOhm
Inductance:	8 nH
Maximum dVdT:	2400v/us
Maximum K0:	760000V ² /us

Packaging Specifications

Package Kind:	Bulk
Package Type:	Bag
Package Quantity:	2000